

# ROUGH COUNTRY

SUSPENSION SYSTEMS®



31400BAG

2019 RAM 1500 4WD 3.5" Lift Kit

Thank you for choosing Rough Country for all your suspension needs.

### DOES NOT FIT TRX PACKAGE VEHICLES!!

Rough Country recommends a certified technician install this system. In addition to these instructions, professional knowledge of disassemble/reassembly procedures as well as post installation checks must be known. Attempts to install this system without this knowledge and expertise may jeopardize the integrity and/or operating safety of the vehicle.

Please read instructions before beginning installation. Check the kit hardware against the kit contents list on the back page. Be sure you have all needed parts and know where they go. Also please review tools needed list and make sure you have the tools needed to install the kit.

### PRODUCT USE INFORMATION

**▲ WARNING** As a general rule, the taller a vehicle is, the easier it will roll. Seat belts and shoulder harnesses should be worn at all times. Avoid situations where a side rollover may occur.

Generally, braking performance and capability are decreased when larger/heavier tires and wheels are used. Take this into consideration while driving. Do not add, alter, or fabricate any factory or after-market parts to increase vehicle height over the intended height of the Rough Country product purchased. Mixing component brands is not recommended.

Rough Country makes no claims regarding lifting devices and excludes any and all implied claims. We will not be responsible for any product that is altered.

We will be happy to answer any questions concerning the design, function, and use of our products.

This suspension system was developed using a 295/60-20 tire, with factory wheels.

### **▲ NOTICE** NOTICE TO DEALER AND VEHICLE OWNER

Any vehicle equipped with any Rough Country product should have a "Warning to Driver" decal installed on the inside of the windshield or on the vehicle's dash. The decal should act as a constant reminder for whoever is operating the vehicle of its unique handling characteristics. By purchasing any item sold by Rough Country, LLC, the buyer expressly warrants that he/she is in compliance with all applicable Federal, State, and Local laws and regulations regarding the purchase, ownership, and use of the item. It shall be the buyers responsibility to comply with all Federal, State and Local laws governing the sales of any items listed, illustrated or sold. The buyer expressly agrees to indemnify and hold harmless Rough Country, LLC for all claims resulting directly or indirectly from the purchase, ownership, or use of the items.

**▲ NOTICE** INSTALLING DEALER - it is your responsibility to install the warning decal and forward these installation

**▲ NOTICE** Note to installer : Before installation begins we recommend that a test drive be performed. While driving check for uncommon sounds and/or vibrations . What you feel and hear during the test drive will only magnify once lift kit is installed. Advise you to discuss possible issues identified from drive with customer before proceeding to install this kit.

#### Tools Needed:

8mm Wrench  
 15mm Socket / Wrench  
 14mm Socket / Wrench  
 17mm Socket / Wrench  
 18mm Socket / Wrench  
 21mm Socket / Wrench  
 22mm Socket / Wrench  
 24mm Socket / Wrench  
 Coil Spring/Strut Compressor

Size	Grade 5	Grade 8
5/16"	15 ft/lbs	20 ft/lbs
3/8"	30 ft/lbs	35 ft/lbs
7/16"	45 ft/lbs	60 ft/lbs
9/16"	95 ft/lbs	130 ft/lbs
	Class 8.8	Class 10.9
10MM	32ft/lbs	45ft/lbs
18MM	170ft/lbs	240ft/lbs



## INSTALLATION INSTRUCTIONS

1. Jack up the front of the vehicle and support the vehicle with jack stands, so that the front wheels are off the ground.
2. Disconnect the electric rack and pinion.
3. Using 22mm socket remove the front tires/wheels.
4. Unclip the ABS wire from the upper control arm. **See Photo 1.**
5. Using a 21mm wrench, remove the tie rod end nut and tie rod end from the knuckle. **See Photo 2.**

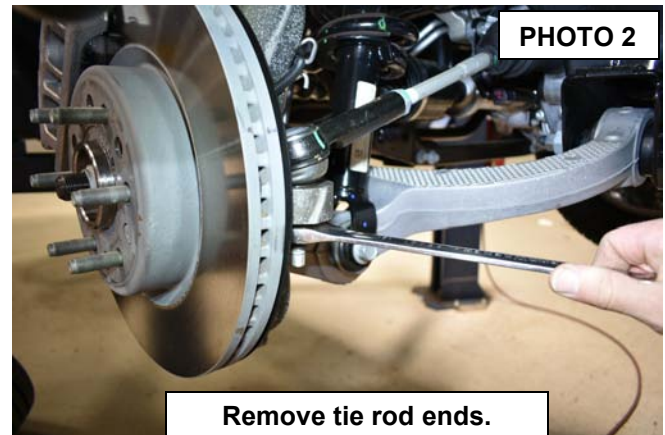
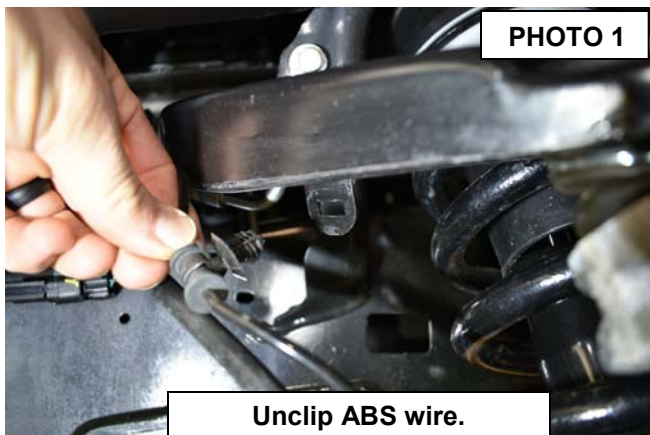

6. Using a 21mm wrench and 24mm socket, remove the lower strut mounting bolt. Retain hardware for reuse. **See Photo 3**
7. Using an 18mm socket, remove the lower sway link nut. Retain hardware for reuse. **See Photo 4.**



8. Using a 21mm wrench, loosen the upper ball joint nut. **Do not completely remove the nut. See Photo 5.**
9. Using a hammer, strike the knuckle at the upper ball joint to release the ball joint from the knuckle. Remove the nut and retain for reuse. **See Photo 6.**

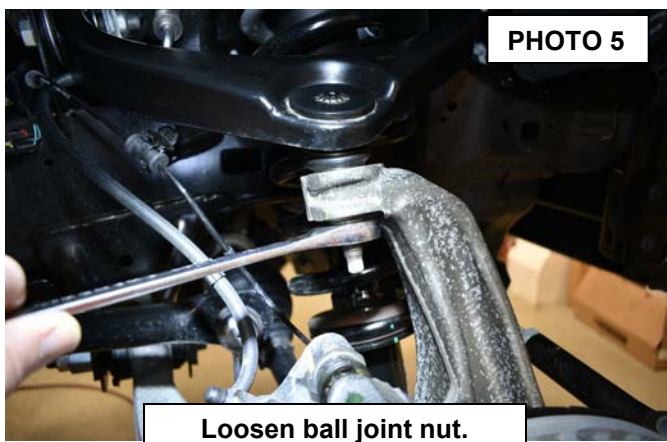

10. Place jack stand under the knuckle for support. Using a 16mm socket, remove the strut nuts on the upper strut tower. Do not allow the knuckle to pull out far enough that it pulls the CV shaft out of the differential. Remove the strut from the truck.



11. Using an 18mm wrench, remove the upper control arm bolts and retain for reuse. Also, remove the upper control arm from the knuckle. **See Photos 7 & 8.**

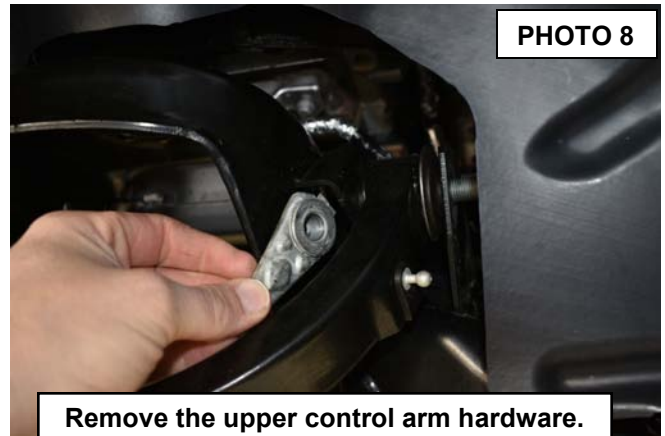

12. Install the new Rough Country upper control arms using the factory hardware on the frame mounts and the supplied hardware on the ball joint. Torque to factory specs. **See Photos 9 & 10. See page 5 for UCA identification.**

**▲ NOTICE** Ball joint must be greased before use.  
Check ball joint grease after the first 100 miles and then every 3000 miles.

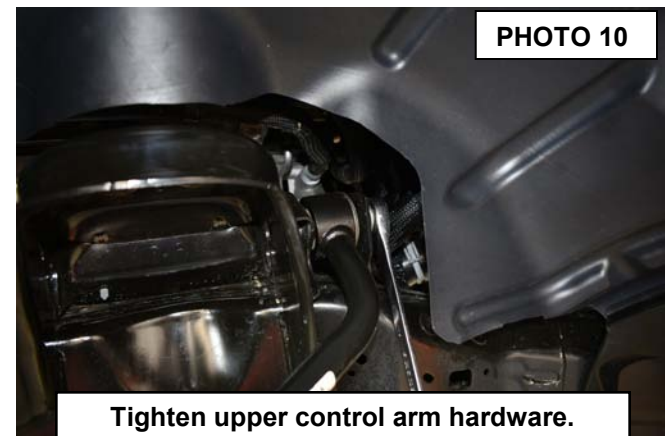

13. Mark the orientation of the strut hat on the strut by making a mark on the strut hat and the strut body.
14. Place a strut compressor on the coil spring and compress the coil, so the strut top nut (**DO NOT USE AN IMPACT**) can be removed. Next remove the strut top and add the preload spacer to the coil assembly. The spacer will fit between the factory coil isolator and the strut top.
15. With the coil spring still compressed assemble the strut, align the marks from step 13, and tighten the strut top nut (**DO NOT USE AN IMPACT**). **See Photo 11.**
16. Using the 1/2" jam nut and one of the 10mm nuts, from 10mmstudbag-1, install the supplied studs into the upper strut spacers. **See Photo 12.**

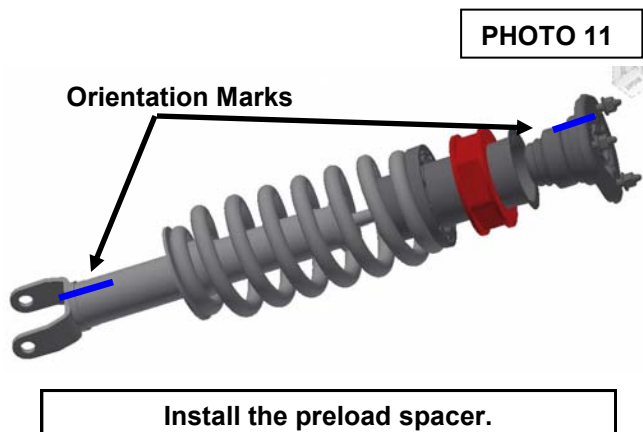

17. Install the strut spacer on the strut, using the factory hardware. **See Photo 13.**
18. Tighten the strut hardware using a 16mm, torque to factory specs. **See Photo 14.**

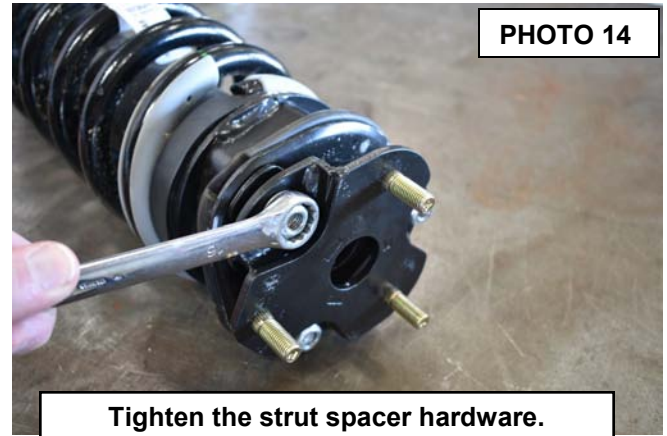
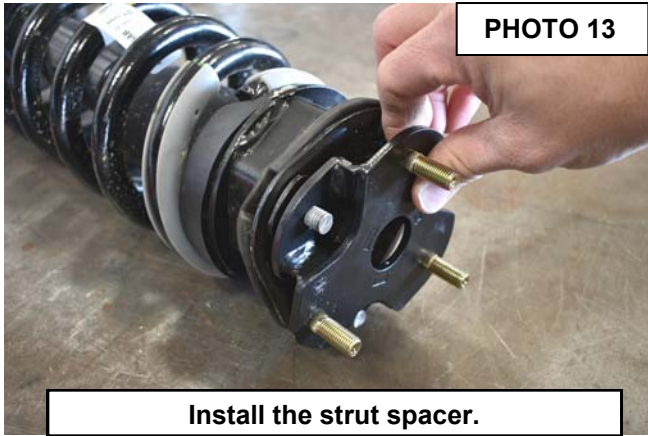

19. Using a grinder, grind the top of the (3) factory studs even with the top of the strut spacer. **See Photos 15 & 16.**

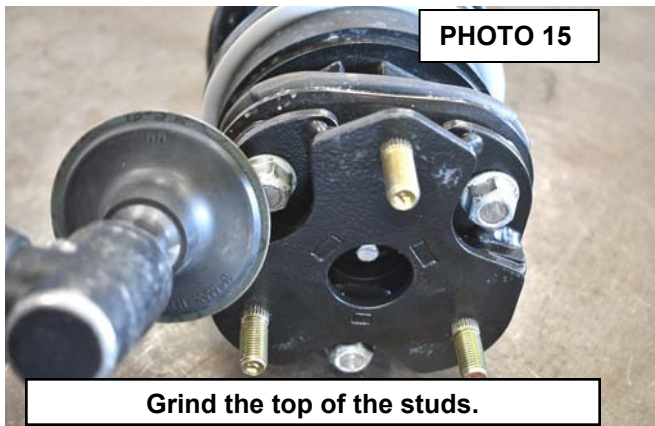

20. Install the strut assembly into the upper frame mount using the supplied 10mm hardware from 10mmstudbag-1. Do not tighten at this time. **See Photo 17.**
21. Install the strut on the lower control arm using the factory hardware. **See Photo 18.**
22. Tighten the upper hardware using a 17mm wrench and the lower using a 24mm socket and 21mm wrench.

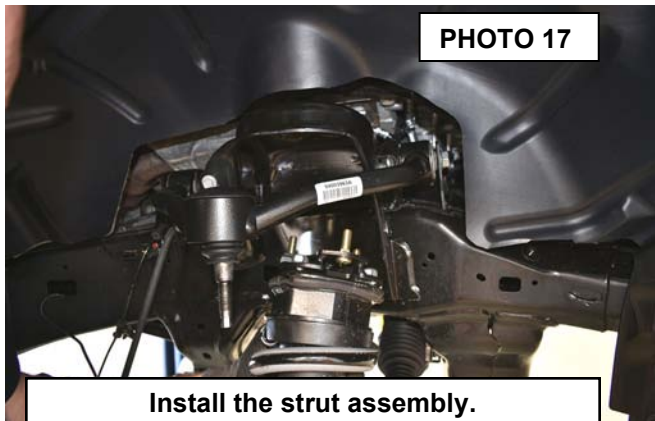

24. Using a floor jack, raise the lower control arm and connect the upper ball joint on the upper control arm to the knuckle. Torque to manufacturer specs.
25. Install the tie rod end nut and tighten using a 21mm socket.
26. Repeat this process on the opposite side of vehicle.
27. Using an 18mm socket reinstall the sway bar links. Torque to factory specs.
28. Install the wheels / tires.
29. Jack up the vehicle and remove the jack stands. Lower the vehicle to the floor and torque all bolts to factory specifications.

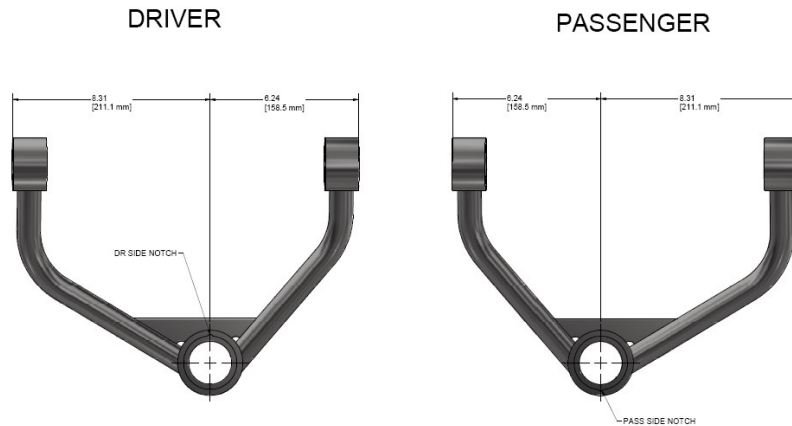

### REAR INSTALLATION

1. Jack up the rear of the vehicle and place jack stands underneath the frame rail.
2. Support the rear axle with a floor jack.
3. Remove the tires and wheels.
4. Remove the stock shocks from the lower shock mount using a 21mm wrench. **See Photo 1.**
5. Remove the sway bar link from the sway bar using a 18mm and 8mm wrench. **See Photo 2.**

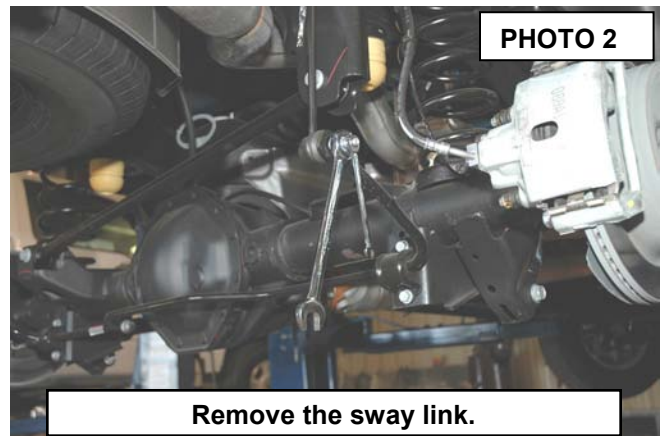

6. Lower the axle with the floor jack and remove the coils springs. **See Photo 3.**
7. Install the flat upper spacer retainer as shown in **Photo 4** on the upper coil seat.

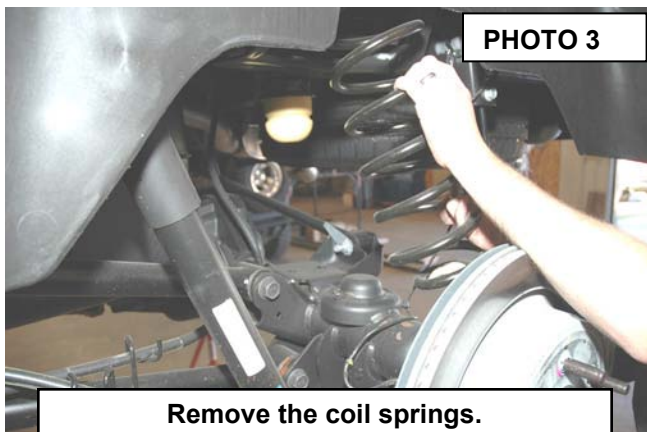

8. Install the spring spacer and secure with the supplied 3/8" x 1 3/4" bolt and washers through the upper flat retainer to hold the spacer in place. Tighten using a 9/16" Socket & wrench. **See Photo 5.**
9. Reinstall the coil spring.
10. Remove the upper shock mounting nut using a 18mm wrench for the nut and a 9mm wrench to hold the shock stud. You may have to remove the fender liner to get to the upper mount.
11. Lift the axle with the floor jack and install the Rough Country N3 shocks (660800) with the stock hardware using a 21mm wrench.
12. Reinstall the sway bar link on the sway bar using a 18mm and 8mm wrench.
13. Reinstall the tires /wheels and remove the jack stands.
14. Lower the vehicle to the ground.

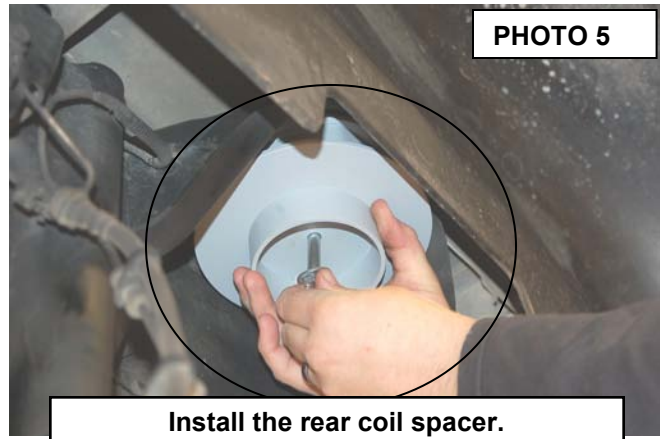

### POST INSTALLATION

1. Check all fasteners for proper torque. Check to ensure there is adequate clearance between all rotating, mobile, fixed and heated members. Check steering for interference and proper working order. Test brake system.
2. Perform steering sweep. The distance between the tire sidewall and the brake hose must be checked closely. Cycle the steering from full turn to full turn to check for clearance.
3. Re torque all fasteners after 500 miles. Visually inspect components and re torque fasteners during routine vehicle service.
4. Readjust headlights to proper settings and take truck in for a front-end alignment to a qualified alignment professional.

### KIT COMPONENTS

#### **KIT CONTENTS:**

- 2-Upper Control Arms
- 2-Front Strut Preload Spacers
- 2-Front Strut Spacers
- 2-Rear Coil Spacers
- 2-Rear Retaining Washers
- 1-31400Bag2 Includes:
  - 2-3/8" x 1 3/4" Bolts
  - 2-3/8" Lock Washers
  - 4-3/8" Flat Washers
- 2-Rear N3 Shocks (660800)



**Thank you for purchasing a Rough Country Suspension System.**

By purchasing any item sold by Rough Country, LLC, the buyer expressly warrants that he/she is in compliance with all applicable Federal, State, and Local laws and regulations regarding the purchase, ownership, and use of the item. It shall be the buyers responsibility to comply with all Federal, State and Local laws governing the sales of any items listed, illustrated or sold. The buyer expressly agrees to indemnify and hold harmless Rough Country, LLC for all claims resulting directly or indirectly from the purchase, ownership, or use of the items.

