

# INSTALLATION GUIDE

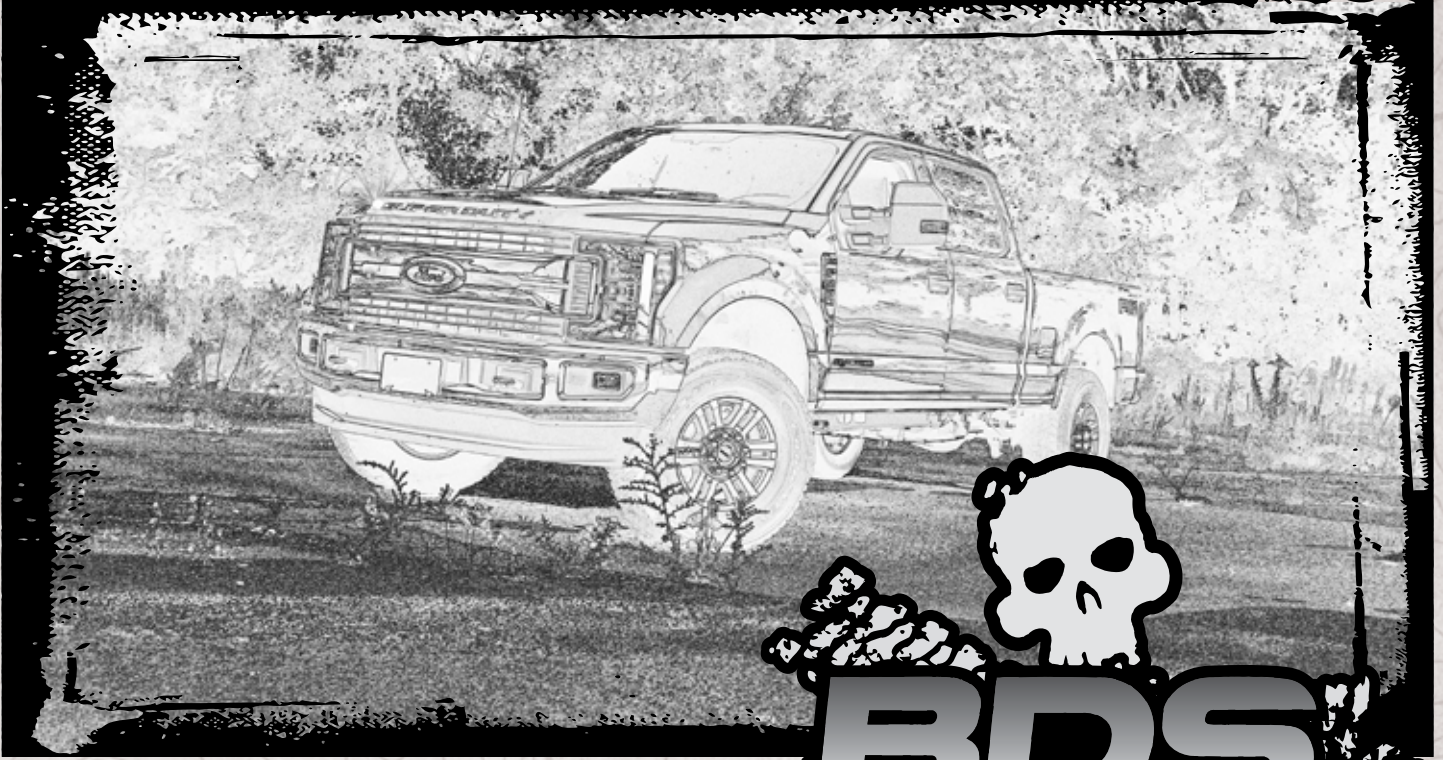

Part#: 013261-013262

**HARDCORE LIMITED LIFETIME WARRANTY**

## **Ford Super Duty 2-1/2" Radius Arm Kit**

**Ford F-250, F350 | 2017-2019**

Rev.100318

491 W. Garfield Ave., Coldwater, MI 49036 • Phone: 517-279-2135  
E-mail: [tech-bds@ridefox.com](mailto:tech-bds@ridefox.com)

# Read And Understand All Instructions And Warnings Prior To Installation Of System And Operation Of Vehicle.



## THANK YOU

Your truck is about to be fitted with the best suspension system on the market today. That means you will be driving the baddest looking truck in the neighborhood, and you'll have the warranty to ensure that it stays that way for years to come. Thank you for choosing BDS Suspension!

### BEFORE YOU START

BDS Suspension Co. recommends this system be installed by a professional technician. In addition to these instructions, professional knowledge of disassembly/ reassembly procedures and post installation checks must be known.

### FOR YOUR SAFETY

Certain BDS Suspension products are intended to improve off-road performance. Modifying your vehicle for off-road use may result in the vehicle handling differently than a factory equipped vehicle. Extreme care must be used to prevent loss of control or vehicle rollover. Failure to drive your modified vehicle safely may result in serious injury or death. BDS Suspension Co. does not recommend the combined use of suspension lifts, body lifts, or other lifting devices. You should never operate your modified vehicle under the influence of alcohol or drugs. Always drive your modified vehicle at reduced speeds to ensure your ability to control your vehicle under all driving conditions. Always wear your seat belt.

### BEFORE INSTALLATION

- Special literature required: OE Service Manual for model/year of vehicle. Refer to manual for proper disassembly/reassembly procedures of OE and related components.
- Adhere to recommendations when replacement fasteners, retainers and keepers are called out in the OE manual.
- Larger rim and tire combinations may increase leverage on suspension, steering, and related components. When selecting combinations larger than OE, consider the additional stress you could be inducing on the OE and related components.
- Post suspension system vehicles may experience drive line vibrations. Angles may require tuning, slider on shaft may require replacement, shafts may need to be lengthened or trued, and U-joints may need to be replaced.
- Secure and properly block vehicle prior to installation of BDS Suspension components. Always wear safety glasses when using power tools.
- If installation is to be performed without a hoist, BDS Suspension Co. recommends rear alterations first.
- Due to payload options and initial ride height variances, the amount of lift is a base figure. Final ride height dimensions may vary in accordance to original vehicle attitude. Always measure the attitude prior to beginning installation.



Visit [560plus.com](http://560plus.com) for more information.

### TIRES AND WHEELS

35x12.50x17(18)(20) Tire  
4-1/2" ~ 5" Backspace Wheel



### BEFORE YOU DRIVE

Check all fasteners for proper torque. Check to ensure for adequate clearance between all rotating, mobile, fixed, and heated members. Verify clearance between exhaust and brake lines, fuel lines, fuel tank, floor boards and wiring harness. Check steering gear for clearance. Test and inspect brake system.

Perform steering sweep to ensure front brake hoses have adequate slack and do not contact any rotating, mobile or heated members. Inspect rear brake hoses at full extension for adequate slack. Failure to perform hose check/ replacement may result in component failure. Longer replacement hoses, if needed can be purchased from a local parts supplier.

Perform head light check and adjustment.

Re-torque all fasteners after 500 miles. Always inspect fasteners and components during routine servicing.

# CONTENTS OF YOUR KIT

## BDS 033251 - 2.5" Coil Springs

| Part #  | Qty | Description  |
|---------|-----|--------------|
| 033251R | 2   | Coil Springs |

## Rear Kit BDS 013407 - 4" Tall Rear Block +3/4" Lift

| Part #      | Qty | Description                          |
|-------------|-----|--------------------------------------|
| 02786       | 2   | 4in Superduty Block w/ Wing          |
| 583181600SB | 4   | 5/8" x 3-1/8" x 16 Semi-Round U-bolt |
| B949        | 1   | Bag Kit - 5/8" U-Bolts               |
| N58FHB      | 8   | 5/8" Fine High Nut - Black           |
| W58SB       | 8   | 5/8" Washer - Black                  |

## BDS 013262 - 2.5" Box Kit - Replacement Radius Arm

| Part # | Qty | Description                        |
|--------|-----|------------------------------------|
| B1254  | 1   | Bag Kit - 2.5" w/ Rad Arm          |
| 422    | 1   | Bolt Pack - Sway Bar Drop          |
| 03510  | 2   | Brake Line Bracket                 |
| 696    | 1   | Bolt Pack - Bump Stop & Brake Line |
| 01253  | 1   | Sway Bar Drop - DRV                |
| 01254  | 1   | Sway Bar Drop - PASS               |
| A291   | 1   | Front Adjustable Trackbar          |
| B1068  | 1   | Bag Kit - Adjustable Trackbar      |
| 3535BK | 2   | Bushing - black                    |
| 107    | 1   | 1.125 x .156 x 1.745 DOM Tube      |
| 516    | 1   | 1/4in - 28 Grease Zerk (#60105)    |
| 3195   | 2   | 3" Dia x 1-1/2" tall bump stop     |

## BDS 123251 - Radius Arm Box Kit

| Part #    | Qty | Description                          |
|-----------|-----|--------------------------------------|
| A241      | 1   | Superduty Replacement Rad Arm - DRV  |
| 02799     | 1   | Superduty Replacement Arm            |
| 868190    | 1   | Rad Arm Bushing                      |
| 97525A430 | 2   | Stainless Rivet                      |
| 02802     | 1   | Stainless Radius Arm Logo Plate      |
| A242      | 1   | Superduty Replacement Rad Arm - Pass |
| 02799     | 1   | Superduty Replacement Arm            |
| 868190    | 1   | Rad Arm Bushing                      |
| 97525A430 | 2   | Stainless Rivet                      |
| 02802     | 1   | Stainless Radius Arm Logo Plate      |
| B1114     | 1   | Bag Kit - Replacement Radius Arm     |
| 02421     | 4   | Caster Cam Plates                    |
| 02002ZP   | 2   | M18-2.50 X 150mm Bolt                |
| N18MPT    | 2   | M18-2.50 Prevailing Torque Nut       |
| W34SAE    | 4   | Washer                               |
| 099002    | 2   | Zip Tie - Push In                    |
| 099000    | 6   | Zip Tie                              |

## TECH TIPS

### TROUBLESHOOTING INFORMATION FOR YOUR VEHICLE

1. Larger tires on stock wheels are not recommended due to brakeline clearance required. Use recommended specifications listed in tire and wheel fitment section.
2. Trackbar mounting bolt requires 405 ft-lbs of torque, plan ahead on how to achieve this.
3. Steering on F-250/F-350 trucks can be stiff from the factory. Replacement radius arms with increased caster typically help this issue. The base 2.5" lift with ball joint cams and or steering stabilizer options will not fix this problem. We have had success in reducing the torque specification to 85 ft-lbs for the upper ball joint. Use this as a last resort to cure factory steering issues.
4. Kit works on Gas model trucks. Gas models will achieve 1/2" more lift in the front.

## INSTALLATION INSTRUCTIONS

### SPECIAL TOOLS

#### INSTALLATION INSTRUCTIONS

1. Park the vehicle on a clean, flat surface and block the rear wheels for safety.
2. Disconnect the trackbar from the frame bracket. Retain OE hardware. It is easiest to disconnect the trackbar before the vehicle is lifted in the air. (Fig 1) Remove the trackbar from the axle end. This can be done by removing the ball joint nut at the axle. Reinstall the nut a couple of turns to prevent damage to OE trackbar joint threads. Use appropriate puller (small pitman arm puller works in most cases) to dislodge the taper from the axle bracket.
3. Remove the stock track bar. If this is used in conjunction with a BDS lift kit with replacement trackbar bracket, save the cam plates. Retain all hardware.

General tools, jacks, jack stands.  
30mm (1-3/16") Socket  
Small Pitman Arm Puller

**FIGURE 1**



4. Raise the front of the vehicle and support under the frame rails with jack stands.



#### Tip

*As a result of the location of the long radius arm suspension, support locations are limited. Use your best judgment while supporting the vehicle with sufficient strength stands at appropriate locations. The radius arms will need to move freely during this installation.*

5. Remove the front wheels.
6. Support the front axle with a hydraulic jack. With the axle supported this installation can be performed on both sides at the same time.

## FRONT DISASSEMBLY:

7. Remove the vacuum line from the top of the radius arm on the driver's side (Fig 2a). Remove the vacuum line from the engine crossmember (Fig 2b).

**FIGURE 2A**



**FIGURE 2B**



8. Remove the brake line bracket from the lower coil seat. Retain hardware. (Fig 3)

**FIGURE 3**



9. Disconnect the brake line bracket frame (Fig 4). Retain hardware.

**FIGURE 4**

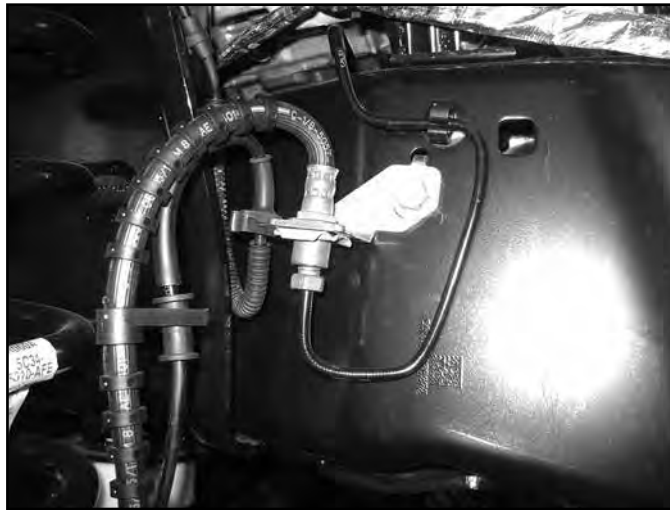

10. Disconnect the shocks by removing factory hardware (Fig 5a, 5b). Retain lower bolt and nut tab for later reinstallation.

**FIGURE 5A**



**FIGURE 5B**



11. Disconnect sway bar from the frame. Retain (4) mounting nuts. (Fig 6)

**FIGURE 6**



12. Lower the axle and remove the factory coil springs.

13. With coil springs out of the way, remove the factory bump stops, then remove the cup from the frame, discard hardware. (Fig 7a, 7b)

**FIGURE 7A**



**FIGURE 7B**



### **RADIUS ARM INSTALLATION (BDS 013262 ONLY):**

14. Working on one side of the vehicle at a time, remove the stock radius arm and replace with the new one. Install cams into the lower slots with new 18m hardware, and use new 18mm nut on the driver's side upper mount at the axle. (Fig 9) The cam will be offset towards the FRONT of the vehicle.

**FIGURE 8**

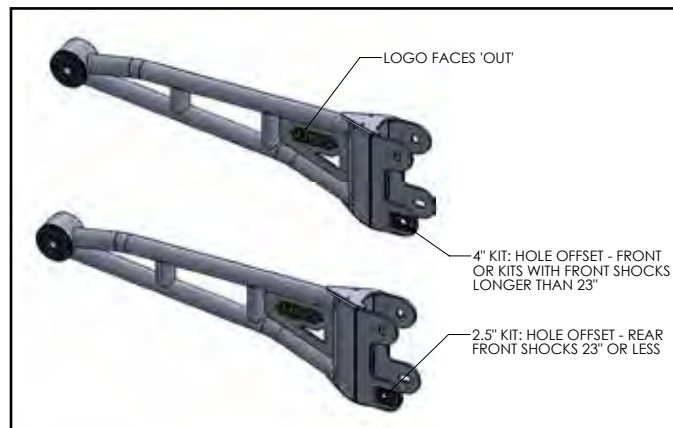

15. Tighten the radius arm hardware at the axle to 150 ft-lbs. Do not tighten the pivot bushing at the frame. (Skip ahead to bump stop installation)

### **BUMP STOP INSTALLATION**

16. Trim off the round edge 1-1/2" from the hole center to have a flat face and coat with paint. This will give extra clearance between the coil spring and cup with the increased wheel travel the kit provides.
17. Install the 1-1/2" bump stop spacer with bump stop cup and 8mm hardware (BP #696). Rotate the bump stop cup so that the newly cut edge is flush with the frame. Note: If installing optional Fox coilovers, the 2" tall bump stop spacer that comes with the coilover mounting brackets will need to be installed. (Fig 9)

**FIGURE 9**



18. Grease the bump stops and reinstall into the factory cups. Raise the axle to get the bump stops to press into the cups. (Fig 10)

**FIGURE 10**

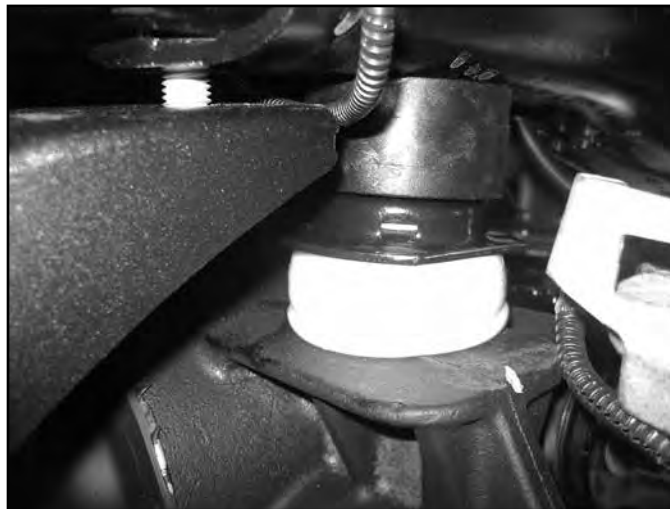

### **COIL AND SHOCK INSTALLATION**

19. If optional coilovers are going to be installed, reference the coilover bracket instruction sheet included with the bracket kit at this time.
20. Grease and install sleeves and bushings into the shocks.
21. BDS (Silver / non-Fox) shocks will require the lower mount to be modified. The sharp, non-formed edge will need to be ground to match the formed profile. Grind this and coat with paint. (Fig 11, 12)



**FIGURE 11**

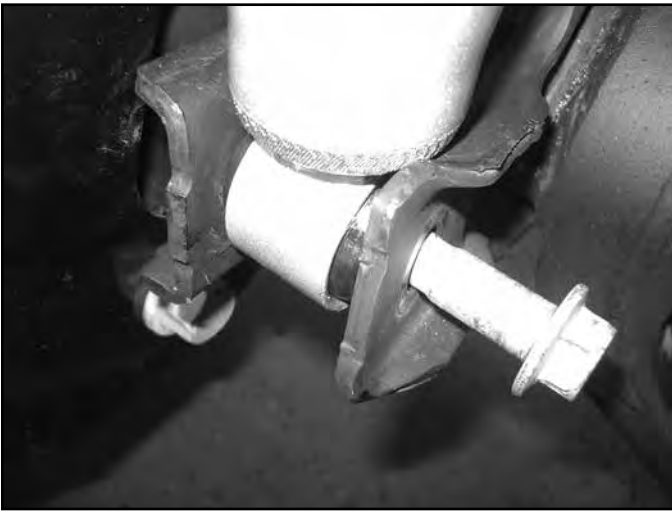

**FIGURE 12**

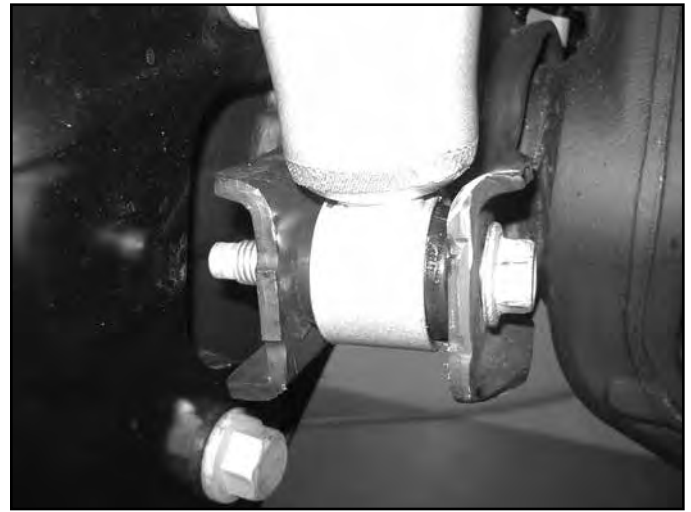

22. Compress the coils slightly by using a hydraulic jack on the axle. Install new shocks with factory lower hardware and stem washers, bushings, and 1/2" fine thread nut on the upper mount. Tighten the upper mount until the bushings begin to swell. Tighten lower mount to 50 ft-lbs.
23. Reattach all brake and vacuum lines to the original locations with the OE mounting hardware and included zip ties. Fox coilovers will have the brackets attach to the lower mounting bracket with included hardware.

#### **ADJUSTABLE TRACKBAR BRACKET INSTALLATION**

24. Grease and install bushings and sleeves into track bar. Thread grease zerks into track bar. Remove (4) allen bolts and apply loc-tite to threads.
25. Attach the trackbar to the axle bracket first. Attach with new 18mm nut. Swing the trackbar up to the frame end and check for clearance at the axle end between the new trackbar gusset and the axle gussets. It may be necessary to grind the axle gussets for clearance. Once clearance is verified, tighten 18mm ball joint nut to 185 ft-lbs. (Fig 13)

**FIGURE 13**



#### **BRAKELINE / SWAY BAR BRACKET INSTALLATION**

26. Install new brakeline relocation brackets with the factory hardware and 1/4" serrated edge flange nut (BP #696). Tighten all hardware to 15 ft-lbs.. (Fig 14a - Pass Side, 14b - Drv Side).

**FIGURE 14A**

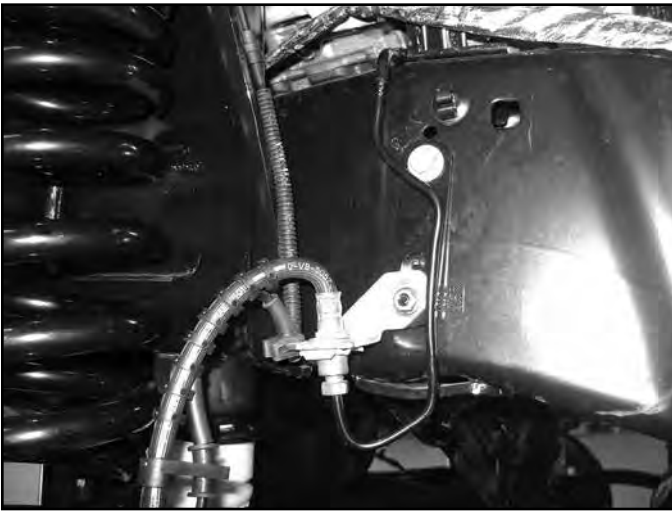

**FIGURE 14B**

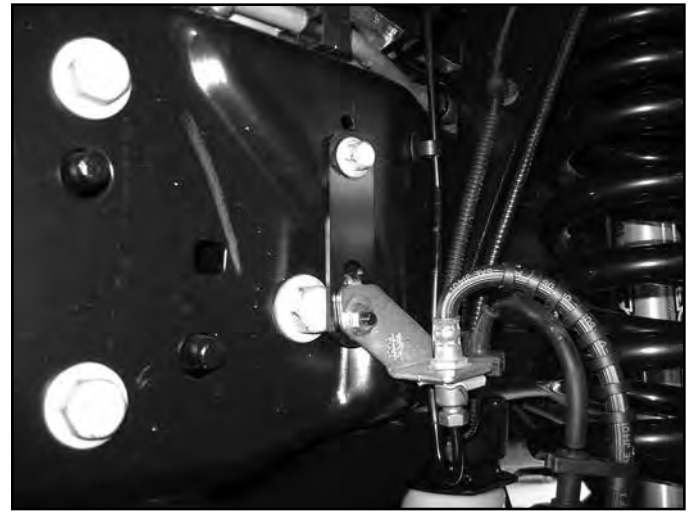

27. Install new sway bar bracket with factory nuts. Slide the brackets as far forward on the vehicle and tighten to 35 ft-lbs.
28. Attach sway bar to the drop bracket with 3/8" hardware (BP #422). Check for sway bar to lower coil mount clearance. Adjust forward / rearward as necessary to have adequate clearance. Tighten to 35 ft-lbs. (Fig 15)

**FIGURE 15**



29. Reinstal wheels and lower vehicle to the ground.
30. Tighten radius arm hardware to 150 ft-lbs.
31. Check for sway bar, sway bar link clearance to lower coil mount. Adjust sway bar mounting to bracket if necessary.
32. Attach the trackbar to the factory bracket with OE hardware. Have an assistant turn the steering wheel to allow hardware installation. Tighten to 405 ft-lbs.
33. Ensure the axle is square under the vehicle. Additional adjustment of the track bar collar may be required. Check the trackbar collar to frame crossmember for adequate clearance. A small amount of grinding on the frame crossmember lip may be required for clearance to the trackbar under compression clearance. (Fig 16)

**FIGURE 16**



34. Adjust steering wheel to center, this will require lengthening of the drag link. Do not drive the vehicle with the steering wheel off-center for extended distances / speeds or a trip to the dealership may be required to reset the computer. Note: if there is less than 1-3/4" of thread engaged in the adjusting collar, the trackbar must be shortened to allow for adequate thread engagement of the drag link.
35. Adjust the clamps on the drag link so that they will not hit the sway bar through wheel travel or steering range of motion.
36. Check hardware after 500 miles.

## **REAR INSTALLATION 4" BLOCK KIT**

37. Block the front wheels for safety.
38. Raise the rear of the vehicle and support with jack stands under the frame rails just ahead of the spring hangers.
39. Remove the wheels.
40. Support the axle with a hydraulic jack.
41. Remove the factory shocks. Retain all mounting hardware.
42. Disconnect the passenger's side spring u-bolts. (Fig 17)

**FIGURE 17**



43. Remove the factory lift block. It will not be reused.
44. Lower the axle enough to place the provided 4" lift block between the axle and the leaf spring. Position the block so the bump stop wing faces inward.
45. Raise the axle to engage the block spring alignment pin. (Fig 18) Fasten the entire assembly with the provided u-bolts, high nuts and washers. Snug but do not torque the u-bolts at this time.

**FIGURE 18**



46. Repeat block installation of the driver's side. Take care not to over extend the brake lines.
47. Install the new shocks with the original mounting hardware. Tighten to 55 ft-lbs.
48. Install wheels and lower the vehicle to the ground.
49. With the weight of the vehicle on the axle, torque the u-bolts to 130-150 ft-lbs. The u-bolts can be trimmed now to the desired length.
50. Torque lug nuts to factory specification.
51. Recheck all hardware for proper torque, check again after 500 miles and at regularly scheduled maintenance intervals.



### **WE WANT TO SEE YOUR RIDE!**

Grab photos of your BDS-equipped truck in action and send them in for a chance to be featured. Send it in to our Bad Ass Rides customer gallery at [bds-suspension.com/bar](http://bds-suspension.com/bar) and post them on the BDS Fan Page on Facebook at [facebook.com/BDSSuspensions](https://facebook.com/BDSSuspensions). Don't forget about your BDS swag! BDS offers t-shirts, hoodies, decals and more available on the BDS website or through your local BDS distributor.

---

## **TIME TO HAVE SOME FUN**

**Thank you for choosing BDS Suspension.**

For questions, technical support and warranty issues relating to this BDS Suspension product, please contact your distributor/installer before contacting BDS Suspension directly.