

ROUGH COUNTRY

SUSPENSION SYSTEMS®

2007 & UP 2WD 3" TOYOTA TUNDRA LEVELING KIT

Thank you for choosing Rough Country for your suspension needs.

Rough Country recommends a certified technician install this system. In addition to these instructions, professional knowledge of disassembly/reassembly procedures as well as post installation checks must be known. Attempts to install this system without this knowledge and expertise may jeopardize the integrity and/or operating safety of the vehicle.

Please read instructions before beginning installation. Check the kit hardware against the parts list on this page and the product layout on the last page. Be sure you have all needed parts and know where they go. Also please review tools needed list and make sure you have needed tools.

PRODUCT USE INFORMATION

▲WARNING As a general rule, the taller a vehicle is, the easier it will roll. Seat belts and shoulder harnesses should be worn at all times. Avoid situations where a side rollover may occur. Generally, braking performance and capability are decreased when larger/heavier tires and wheels are used. Take this into consideration while driving. Do not add, alter, or fabricate any factory or after-market parts to increase vehicle height over the intended height of the Rough Country product purchased. Mixing component brands is not recommended.

Rough Country makes no claims regarding lifting devices and excludes any and all implied claims. We will not be responsible for any product that is altered. If questions exist about the design, function, installation, and correct use of our products please call one of our customer service representatives at 800-222-7023.

This suspension system was developed using a Maximum tire size of 305/65-18 (33" diameter) tire with factory wheels. For aftermarket wheel and tire combinations consult your tire and wheel specialist.

▲NOTICE This kit was designed to level the front of the truck with the rear. This kit includes a strut spacer and strut spacer shim plates to "fine tune" the front with the rear. Before installation is initiated, measure the front and rear of the vehicle to determine how much lift will be needed to level the vehicle. Each shim plate represents approx 3/8" of lift and will be installed on top of the strut spacer as shown in the instruction sheet. (Maximum 2 per side). The spacer alone without shim plates will achieve approx 2 1/4" of lift, can be used without strut spacer shims if desired.

In some cases, the vehicle owner may want the rear of the vehicle lifted also. Rough Country offers an optional 1 1/2" block and u-bolt kit is also available to raise the rear if desired. Part # 6559.

▲NOTICE NOTICE TO DEALER AND VEHICLE OWNER

Any vehicle equipped with any Rough Country product should have a "Warning to Driver" decal installed on the inside of the windshield or on the vehicle's dash. The decal should act as a constant reminder for whoever is operating the vehicle of its unique handling characteristics.

INSTALLING DEALER - it is your responsibility to install the warning decal and forward these installation instructions on to the vehicle owner for review. These instructions should be kept in the vehicle for its service life.

▲NOTICE Note to installer : Before installation begins we recommend that a test drive be performed. While driving check for uncommon sounds and/or vibrations . What you feel and hear during the test drive will only magnify once lift kit is installed. We advise you to discuss possible issues identified from drive with customer before proceeding to install this kit.

TORQUE SPECS:

Size	Grade 5	Grade 8
3/8"	30 ft/lbs	35 ft/lbs
9/16"	95 ft/lbs	130 ft/lbs

KIT CONTENT:

2-Front Strut Spacers
 4-Front Strut Spacer Shim Plates
 4-Bumpstop Spacers
 1-Kit Bag that includes:
 8-3/8" nut
 8-3/8" lock washer

TOOLS NEEDED:

Hammer
 9/16" Wrench
 13/16" Wrench
 10mm Wrench
 12mm Wrench
 14mm Wrench
 19mm Wrench

Metric
 8mm 25ft/lbs
 10mm 42 ft/lbs.
 12mm 70 ft/lbs.
 14mm 95 ft/lbs.
 16mm 200ft./lbs
 18mm 475ft./lbs

FRONT INSTALLATION

1. Park the vehicle on a level surface and chock the rear wheels.
2. Measure the front / rear to determine how much lift will be needed to level the vehicle. FR_____RR_____
3. Jack up the front of the vehicle using a floor jack. Place jack stands under the frame rails directly behind the lower control arms and lower the vehicle onto the jack stands.
4. Remove the tires and wheels.
5. Remove the sensor wire bracket as shown in **Photo 1** using a 10MM wrench. **Take care not to overextend or damage this wire.** Retain the hardware for reuse.
6. Remove the upper strut nuts as shown in **Photo 2** using a 14MM wrench. Retain hardware.

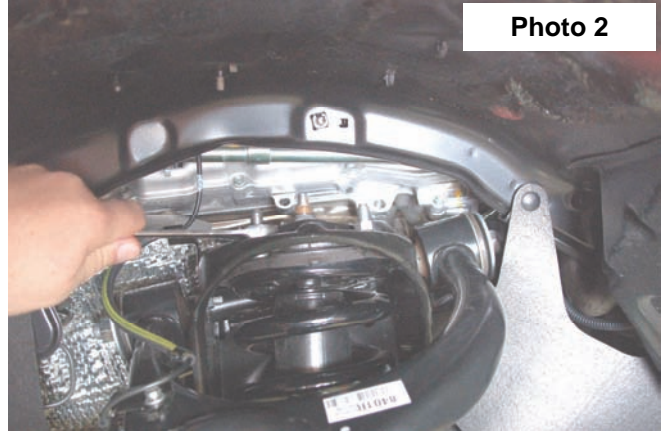
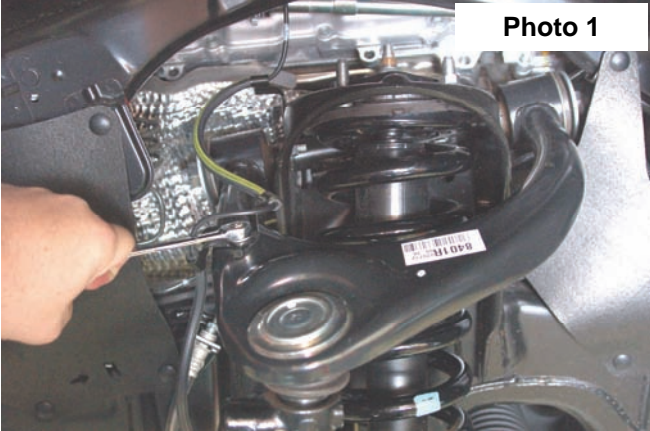

7. Remove the sway bar link from the lower control arms using a 19MM wrench. **See Photo 3.** Retain hardware.
8. Loosen, but do not remove the lower control arm bolts to allow the lower control arm to swing down using a 24MM wrench. **See Photo 4.**

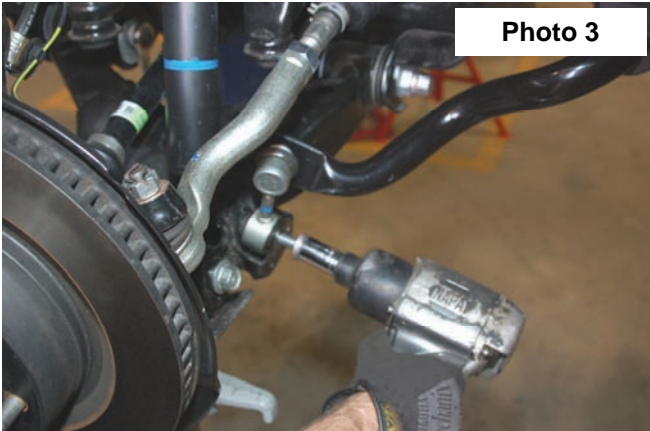

9. Remove the brake line bracket from the knuckle using a 12MM wrench.
10. Remove the upper ball joint nut using a 19MM wrench as shown in **Photo 5.** It may be necessary to hit side of the knuckle to brake the taper lock loose.
11. Remove the lower strut bolts as shown in **Photo 6** using a 22MM socket and wrench. Remove the strut from the vehicle.

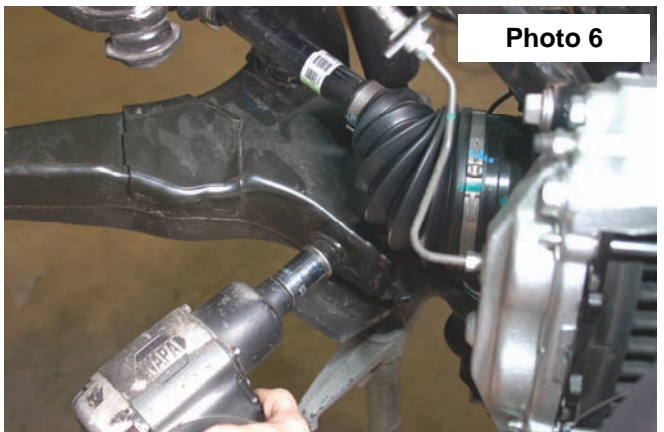

12. Install the new strut spacer on the top of the factory strut using the factory hardware making sure to position the strut spacer as shown in **Photo 7** with the flat part of the spacer toward the frame rail. Tighten hardware.
13. Install the shim plates on the strut as shown in **Photo 8**. The shim plates are included to allow the height to be set as needed. If less lift is desired, one or both of the shim plates may be left off the strut spacer and will in turn give less lift. Each spacer shim plate will give approx 3/8" of lift. **Refer to measurement taken in Step 2.**
14. Install the strut in the factory mount with the supplied 3/8" nuts and lock washers on the upper mount and the factory hardware on the bottom arm

▲ NOTICE THE STRUT SPACER IS NOT SYMETRICAL, THE FLAT ON THE SPACER MUST FACE THE FRAME ON EACH SIDE. Using a 9/16" wrench on the upper and a 22mm socket on the lower mount tighten the hardware.

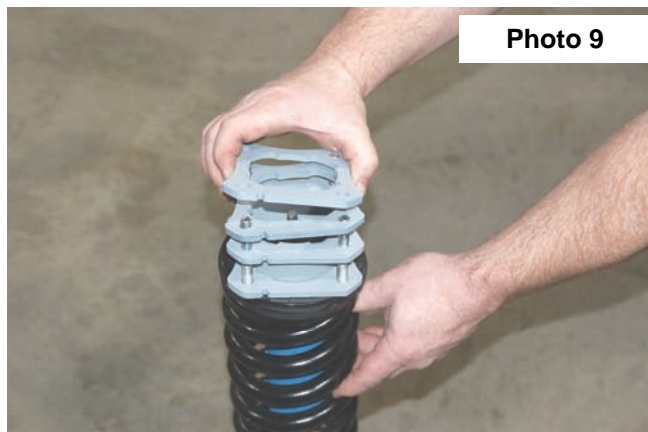
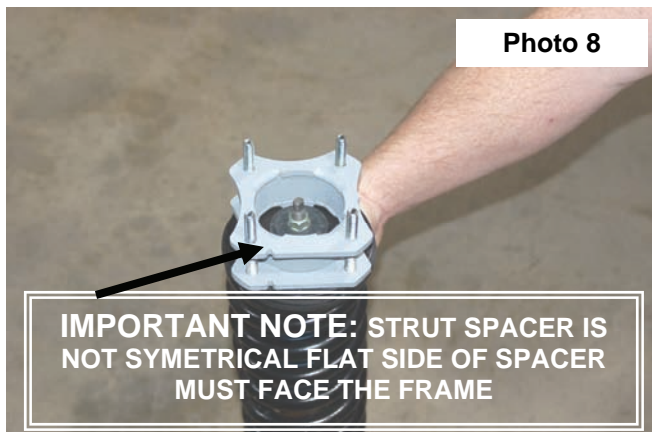

15. Remove the (4) factory bump-stops and install the supplied bump-stop spacers in the factory locations. Then install the factory bump-stops into the spacers. **See Photo 10.**
16. Tighten the bump-stops to factory specs. **See Photo 11.**

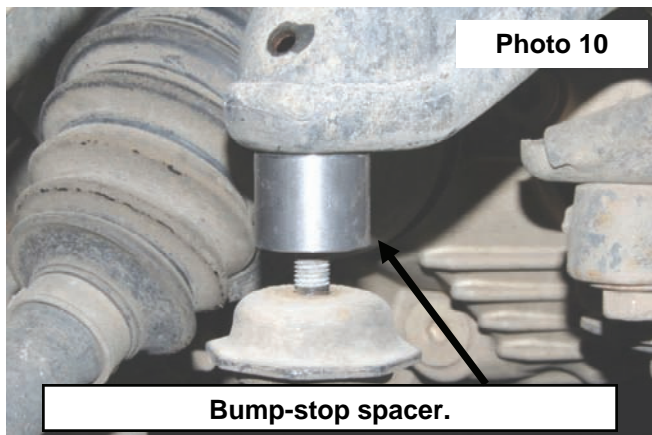

POST INSTALLATION

1. Check and recheck all fasteners for proper torque. Check to ensure there is adequate clearance between all rotating, mobile, fixed and heated members. Check clearance between upper control arm and sidewall of tire for proper clearance. Check steering for interference and proper working order. Test brake system.
2. Perform steering sweep. Cycle the steering from full turn to full turn to check for clearance. Failure to perform inspections may result in component failure.
3. Re torque all fasteners after 500 miles. Visually inspect components and re torque fasteners during routine vehicle service.
4. Adjust headlights to proper settings given increased vehicle height.

MAINTENANCE INFORMATION

It is the ultimate buyers responsibility to have all bolts/nuts checked for tightness after the first 500 miles and then every 1000 miles. Wheel alignment steering system, suspension and driveline systems must be inspected by a qualified professional mechanic at least every 3000 miles.

KIT CONTENT:

FRONT UPPER STRUT EXTENSION —2

FRONT UPPER STRUT SHIM PLATES—4

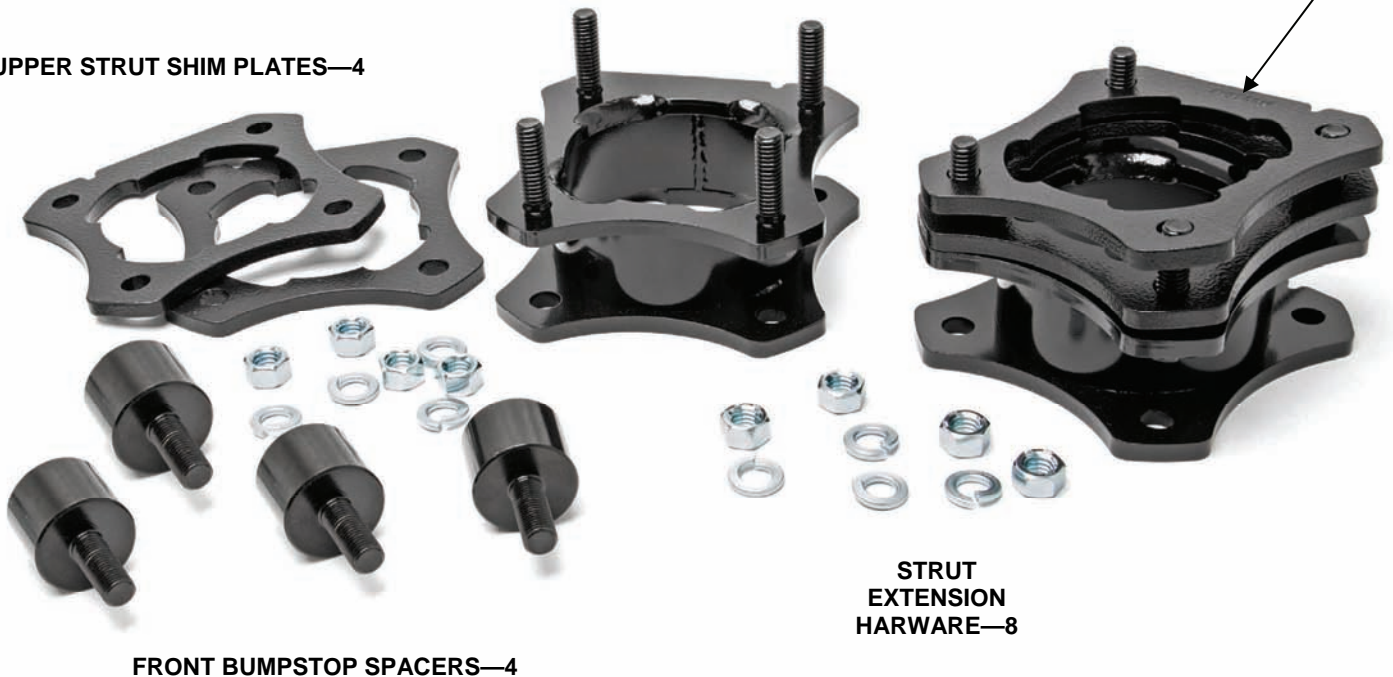

▲ NOTICE

IMPORTANT NOTE: STRUT SPACER IS NOT SYMETRICAL FLAT SIDE OF SPACER MUST FACE THE FRAME

Optional Rear 1 1/2" block / U-bolt kit- Part #6559

Thank you for purchasing a Rough Country Suspension System.

By purchasing any item sold by Rough Country, LLC, the buyer expressly warrants that he/she is in compliance with all applicable, State, and Local laws and regulations regarding the purchase, ownership, and use of the item. It shall be the buyers responsibility to comply with all Federal, State and Local laws governing the sales of any items listed, illustrated or sold. The buyer expressly agrees to indemnify and hold harmless Rough Country, LLC for all claims resulting directly or indirectly from the purchase, ownership, or use of the items.

